

The PermaPorch® Railing Collection

- Virtually Maintenance Free
- Pre-finished (ready to install or can be painted)
- Easy Installation
- As Versatile as Treated Lumber
- Available in Pre-built Sections
- Deck Options Available
- 10/25 Year Warranty
- Complete Kits Available



12" Round PermaCast® Column with Savannah PermaPorch® Railing

The PermaPorch® Railing system is a beautiful way to tie your whole porch look together. It is made up of several different components, allowing you the ability to create the designs

that match your way of life. Easy to install, this worry free railing system will be a beautiful, low maintenance addition to your porch or deck for generations to come.

Porch Railing

Deck Railing

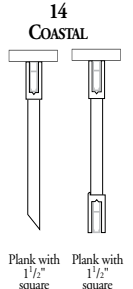
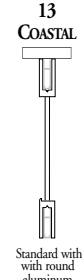
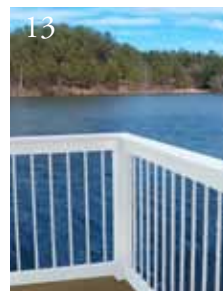
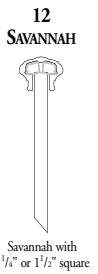
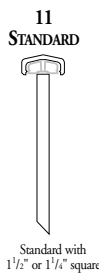
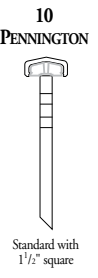
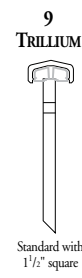
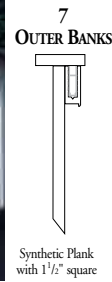
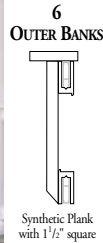
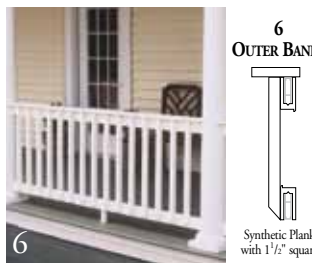
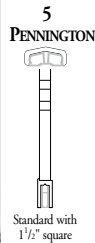
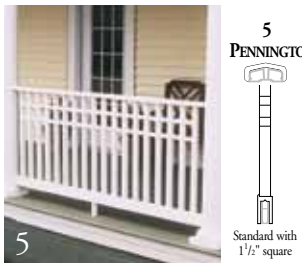
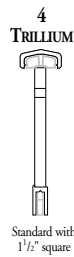
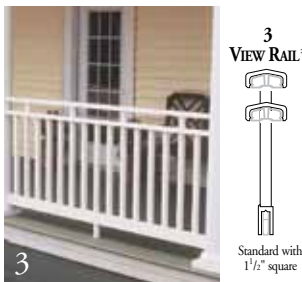
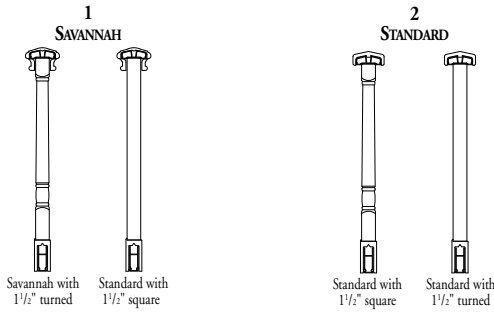

All rail sections suitable with columns (as shown) or PermaPost
* Top Rail Section must be installed on site.

Pre-built PermaPorch® Railing

Pre-built PermaPorch® Railings are available in a variety of styles to match your porch and deck design. The top and bottom rails are made of pre-finished weather resistant cellular PVC with aluminum inserts.



Savannah PermaPorch® Railing and 5" Square PermaPost®

The top rail, bottom rail and balusters are available in pre-finished white. They are made from weather resistant cellular PVC. The balusters are also available in round aluminum.

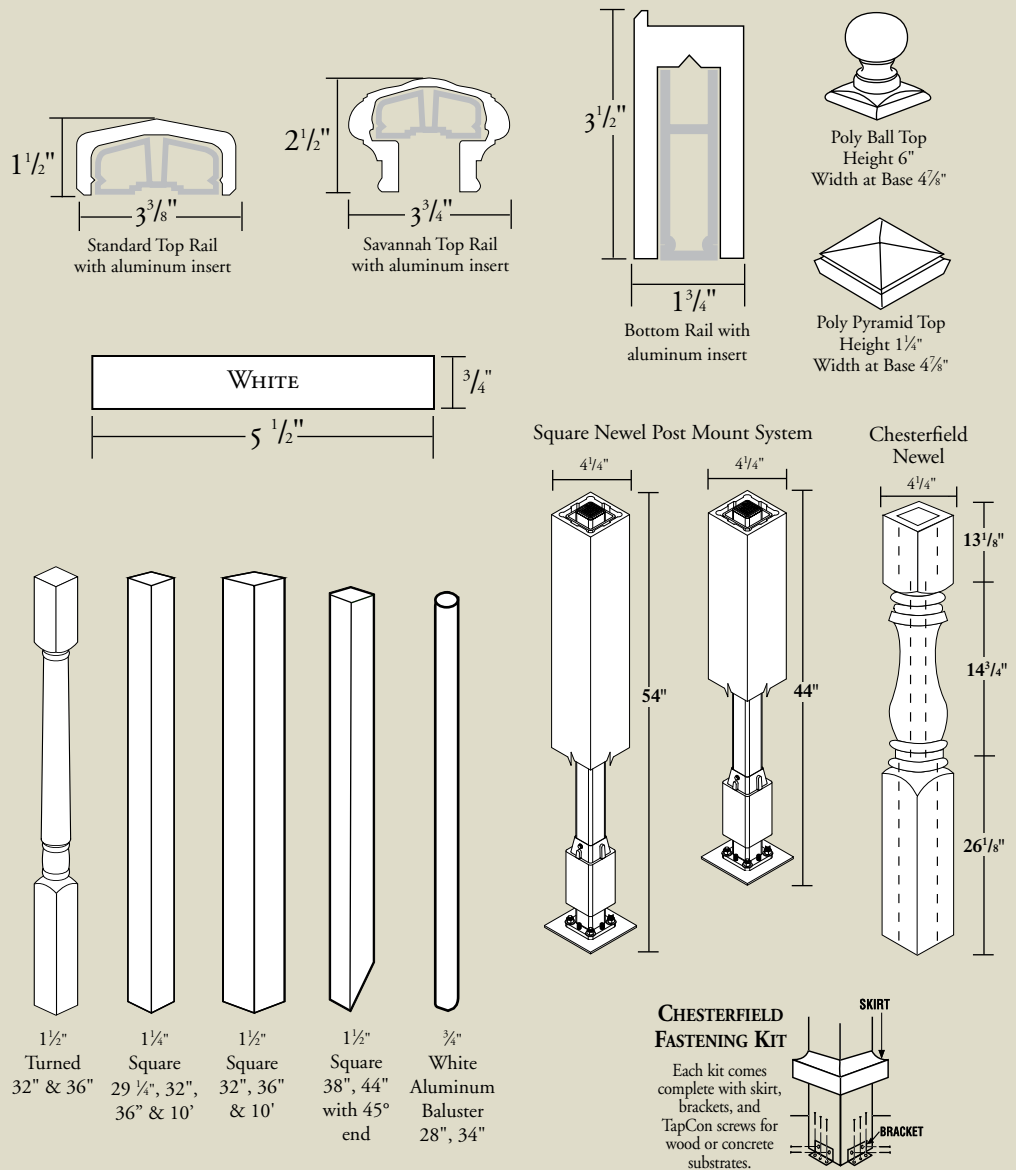

Custom Rail Panels

Custom rail panels are now available! Use our custom rail patterns to create a beautiful, one of a kind look that will set any home apart. HB&G's new rail panels are designed to work with the PermaPorch Railing top and bottom rails, they are made of cellular PVC and can be manufactured using your design or you can choose from one of the styles below. Contact a customer service representative now to order your custom rail panel.

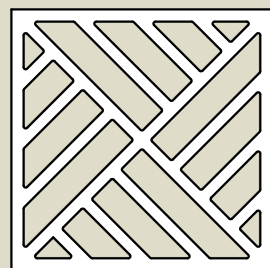

Chippendale

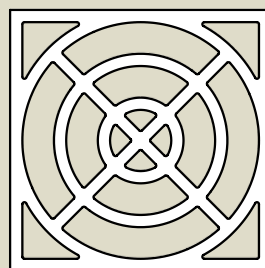

Circle Center

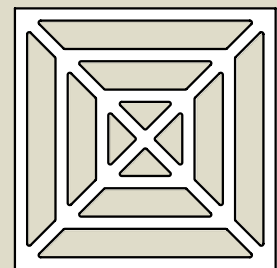

Spiderweb

HB&G has a wide range of PermaPorch® Railing styles and designs, and now with the new curved PermaPorch® Railing HB&G's line of rail products can meet the needs of any application. The curved PermaPorch® Railing is available with either the Standard or Savannah top rail with wood inserts. Radius from 60" to 240" are available in 8 foot sections. Balusters sold separately. For lead time and ordering info, call 1-800-264-4HBG.

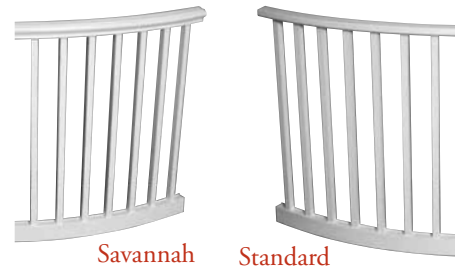

Three Ways to Order the PermaPorch® Railing...

1. PRE-BUILT SECTIONS

- Shipped factory assembled
- Easy to install
- Everything needed to install is included
- How to order
 - Choose length – 4', 6', or 8' sections
 - Choose desired style from page 33 and 34
 - Note rail height (36" or 42")
- Onsite trimming ensures exact fit

2. DO-IT-YOURSELF KIT

- Rail Section shipped in one box.
- Balusters are included in box. *
- Everything needed to assemble and install is included.
- How to order:
 - Choose length – 6' or 8'.
 - Choose style – Savannah or Standard.
- Kit includes:
 - Savannah or Standard top rail.
 - Bottom rail.
 - Aluminum inserts.
 - 1½" x 29¼" square balusters.
 - 8' = 18 balusters.
 - 6' = 14 balusters
 - Assembly and installation hardware.
 - Support block.
- Available in 36" rail height only.

*Screws for balusters are not included.

3. INDIVIDUAL COMPONENTS

- Build your own design
- Mix and match components
- For a complete rail system you will need the following:
 - Top rail – standard or savannah
 - Top insert – aluminum, 8', 10', 12'
 - Balusters – 29¼", 32", 36" and 10' (Balusters may need to be trimmed for desired rail height)
 - Bottom rail
 - Bottom insert – aluminum, 8', 10', 12'
 - Support block
 - Fastening kit

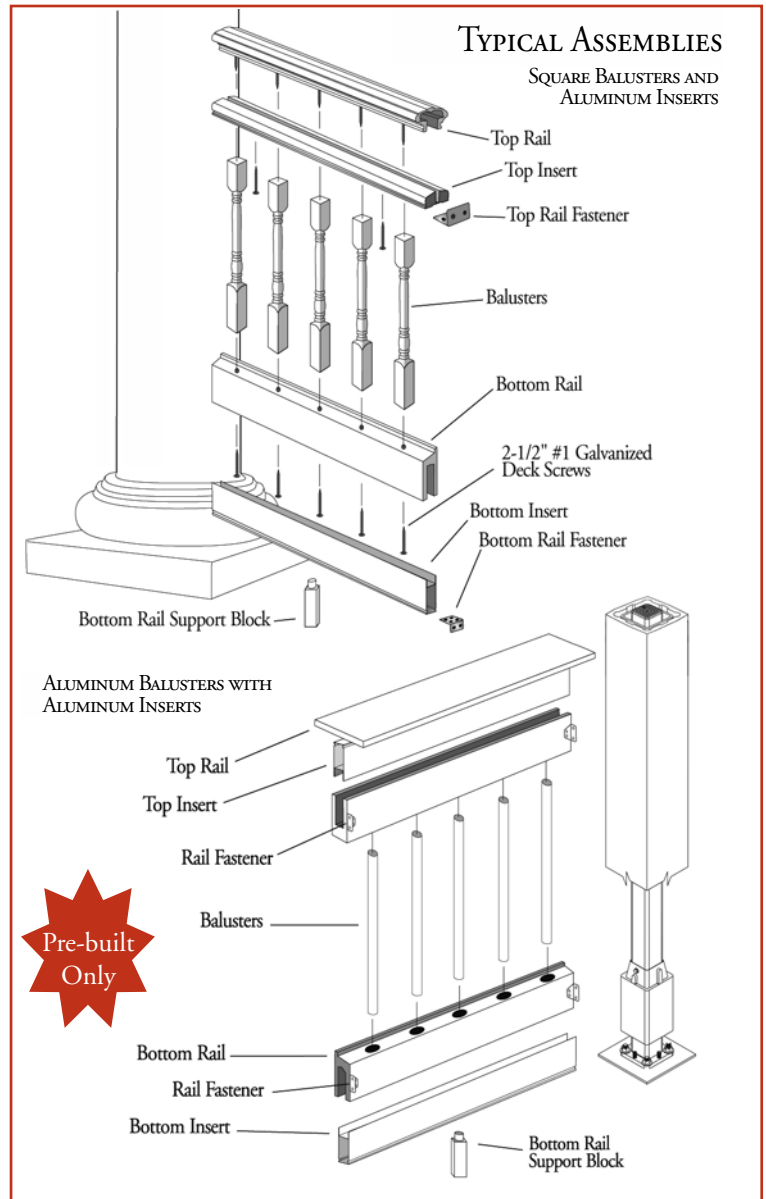

Warranty

HB&G Building Products, Inc. warrants that for 25 years the PermaPorch® Railing is free from defects in material and workmanship. The factory applied top coat (paint) is warranted for 10 years. Assuming proper installation, HB&G Building Products, Inc. will repair or replace any PermaPorch Railing which has failed as a result of defective materials or workmanship. In the event of a claim against this warranty, proof of purchase, with date will be required to affect such a claim. Installation cost not included. HB&G Building Products, Inc. gives no other warranty expressed or implied. For complete warranty visit www.hbgcolumns.com.